

SOLID WOOD ONLY[®]

KARPENTER[®]
Designed by Us Defined by Nature

PETUNJUK PERAKITAN

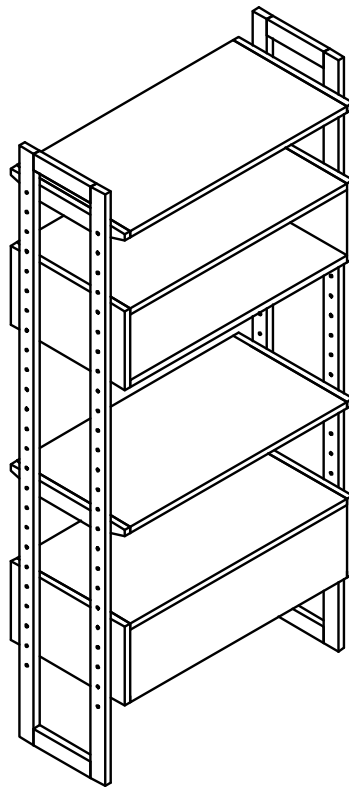



K/WSU
UNIT RAK SINGLE



PINDAI



-  45 KG
-  4/5 (HARD)
-  ¼ 20 MINS

PESANAN ANDA AKHIRNYA DATANG! SEBELUM MERAKIT PRODUK INI, PASTIKAN ANDA MEMBACA SELURUH PETUNJUKNYA DENGAN CERMAT.

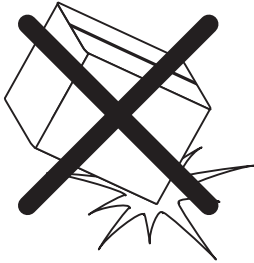

BERHATI-HATILAH DALAM MERAKIT PRODUK DAN PASTIKAN SEMUA KOMPONEN KAYU SOLIDNYA TIDAK TERJATUH.

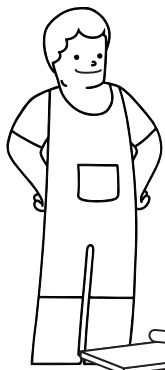

DIBUTUHKAN 2 ORANG UNTUK MERAKIT PRODUK INI.

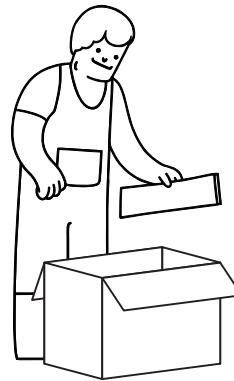

TEMUKAN KODE HURUF (A, B, C,..) ATAU ANGKA (1, 2, 3,..) PADA SETIAP BAGIAN.



LETAKKAN SELURUH KOMPONEN DI ATAS KARPET ATAU ALAS YANG TERDAPAT PADA KARDUS KEMASAN PRODUK.



SEPERANGKAT
KOMPONEN YANG TERDAPAT
DALAM KARDUS

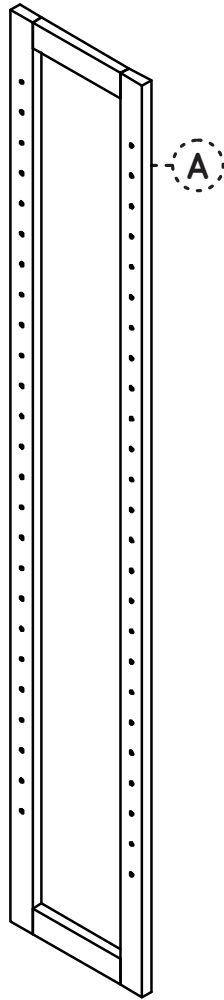

Khaki - 2 pcs

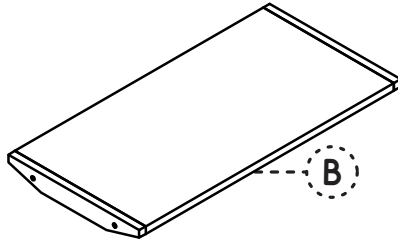

Rak - 2 pcs

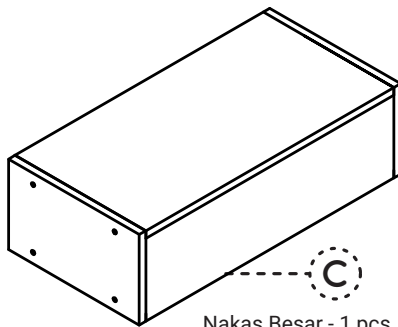

Nakas Besar - 1 pcs

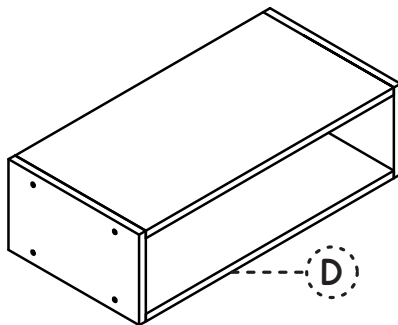

Nakas Kecil - 1 pcs

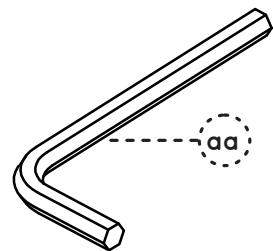

Kunci L - 1 pc

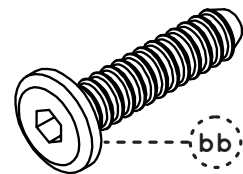

Baut - 24 pcs

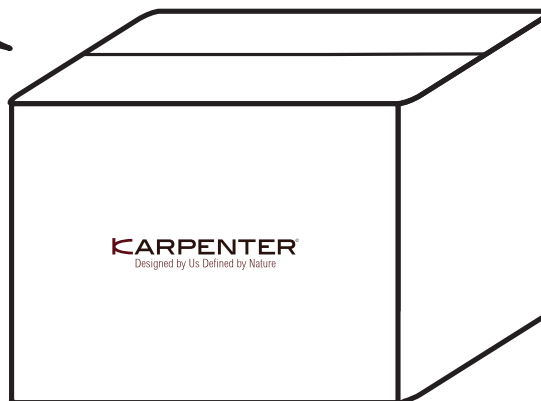

1

PASANG RAK (B) DAN NAKAS BESAR (C) PADA KEDUA KAKI (A).
KENCANGKAN DENGAN BAUT (BB) DAN KUNCI L (AA).

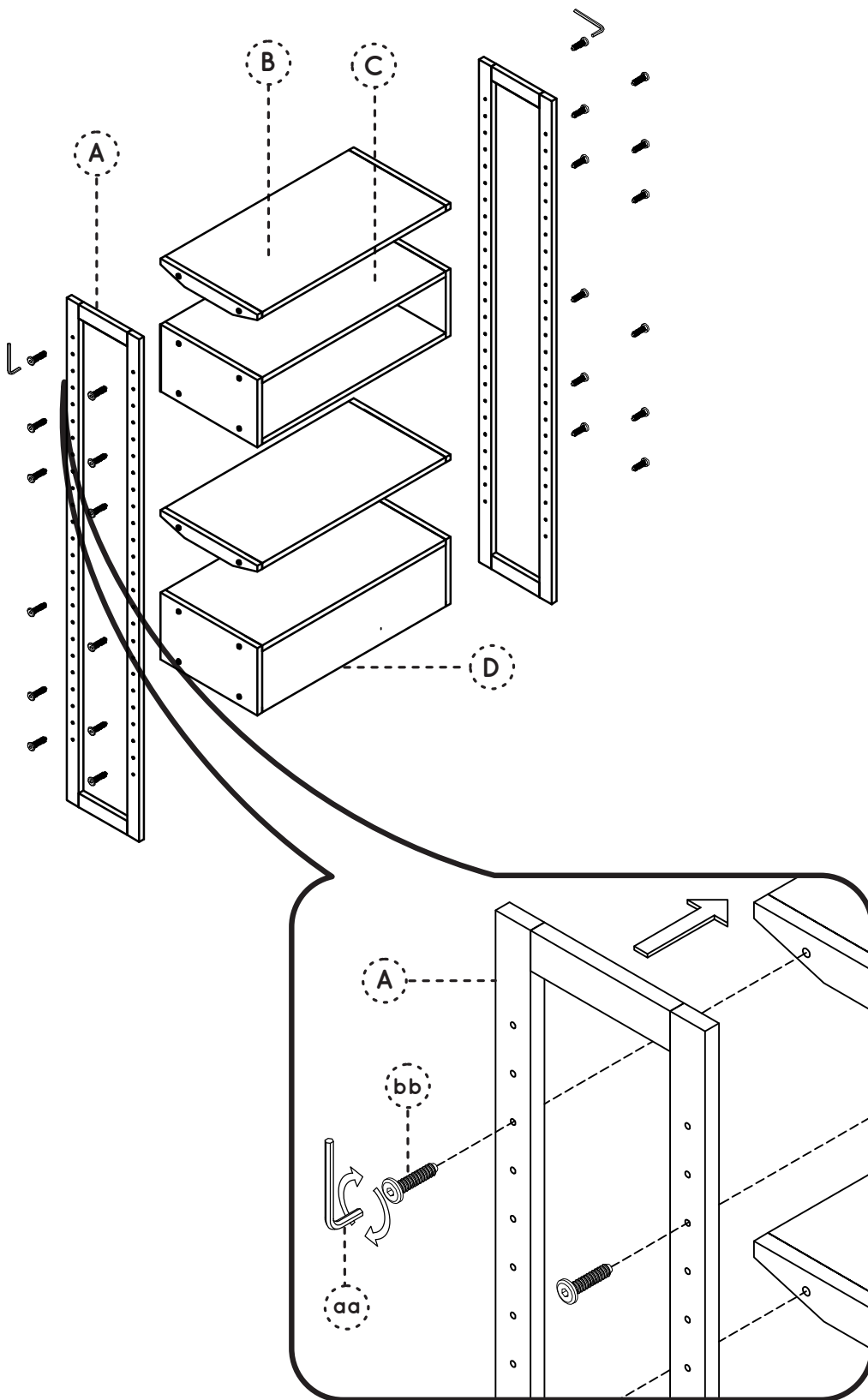

2

PERAKITAN TELAH SELESAI DAN VOILÀ,
K/WSU UNIT RAK SINGLE ANDA SIAP UNTUK DIGUNAKAN!

